



**Caratteristiche:**

Griglie di ripresa ad alette fisse inclinate di 45° passo 25 mm.

**Costruzione:**

Alluminio anodizzato.

**Impiego:**

A parete, in ripresa.

**Fissaggio:**

- Fissaggio standard con clips.
- Fori per viti a richiesta.
- Calamite a richiesta.
- Morsetti a richiesta.

**Accessori:**

- Plenum in acciaio zincato standard o isolato.
- Serranda di taratura in acciaio zincato con alette a movimento contrapposto.
- Controtelaio di montaggio in lamiera di acciaio zincata.

**Characteristics:**

Return grilles with fixed and 45° inblined bars 25 mm pitch.

**Construction:**

Anodized aluminium.

**Utilization:**

For wall installation and for air intake.

**Fixing:**

- Standard fixing by clips.
- Holes for screws upon request.
- Magnets on request.
- Lock upon request.

**Accessories:**

- Galvanized steel plenum, standard or insulated.
- Calibration damper made of galvanized steel and fins with opposite movement.
- Mounting counterframes made of galvanized steel sheet.







PREZZI / PRICES

|            | GRA | GRA-R | GRA-R-Z | GRA-R-SS | SC | CT | PBZ 1 | PBZI 1 | PBZ 2 | PBZI 2 |  |
|------------|-----|-------|---------|----------|----|----|-------|--------|-------|--------|--|
| BxH (mm)   | €   | €     | €       | €        | €  | €  | €     | €      | €     | €      |  |
| * 200x100  | -   | -     | -       | -        | -  | -  | -     | -      | -     | -      |  |
| * 300x100  | -   | -     | -       | -        | -  | -  | -     | -      | -     | -      |  |
| * 400x100  | -   | -     | -       | -        | -  | -  | -     | -      | -     | -      |  |
| * 500x100  | -   | -     | -       | -        | -  | -  | -     | -      | -     | -      |  |
| * 600x100  | -   | -     | -       | -        | -  | -  | -     | -      | -     | -      |  |
| • 800x100  | -   | -     | -       | -        | -  | -  | -     | -      | -     | -      |  |
| • 1000x100 | -   | -     | -       | -        | -  | -  | -     | -      | -     | -      |  |
| • 1200x100 | -   | -     | -       | -        | -  | -  | -     | -      | -     | -      |  |
| * 200x150  | -   | -     | -       | -        | -  | -  | -     | -      | -     | -      |  |
| * 300x150  | -   | -     | -       | -        | -  | -  | -     | -      | -     | -      |  |
| * 400x150  | -   | -     | -       | -        | -  | -  | -     | -      | -     | -      |  |
| * 500x150  | -   | -     | -       | -        | -  | -  | -     | -      | -     | -      |  |
| * 600x150  | -   | -     | -       | -        | -  | -  | -     | -      | -     | -      |  |
| • 800x150  | -   | -     | -       | -        | -  | -  | -     | -      | -     | -      |  |
| • 1000x150 | -   | -     | -       | -        | -  | -  | -     | -      | -     | -      |  |
| • 1200x150 | -   | -     | -       | -        | -  | -  | -     | -      | -     | -      |  |
| * 200x200  | -   | -     | -       | -        | -  | -  | -     | -      | -     | -      |  |
| * 300x200  | -   | -     | -       | -        | -  | -  | -     | -      | -     | -      |  |
| * 400x200  | -   | -     | -       | -        | -  | -  | -     | -      | -     | -      |  |
| * 500x200  | -   | -     | -       | -        | -  | -  | -     | -      | -     | -      |  |
| * 600x200  | -   | -     | -       | -        | -  | -  | -     | -      | -     | -      |  |
| • 800x200  | -   | -     | -       | -        | -  | -  | -     | -      | -     | -      |  |
| • 1000x200 | -   | -     | -       | -        | -  | -  | -     | -      | -     | -      |  |
| • 1200x200 | -   | -     | -       | -        | -  | -  | -     | -      | -     | -      |  |
| * 200x300  | -   | -     | -       | -        | -  | -  | -     | -      | -     | -      |  |
| * 300x300  | -   | -     | -       | -        | -  | -  | -     | -      | -     | -      |  |
| * 400x300  | -   | -     | -       | -        | -  | -  | -     | -      | -     | -      |  |
| * 500x300  | -   | -     | -       | -        | -  | -  | -     | -      | -     | -      |  |
| * 600x300  | -   | -     | -       | -        | -  | -  | -     | -      | -     | -      |  |
| • 800x300  | -   | -     | -       | -        | -  | -  | -     | -      | -     | -      |  |
| • 1000x300 | -   | -     | -       | -        | -  | -  | -     | -      | -     | -      |  |
| • 1200x300 | -   | -     | -       | -        | -  | -  | -     | -      | -     | -      |  |
| 200x400    | -   | -     | -       | -        | -  | -  | -     | -      | -     | -      |  |
| * 300x400  | -   | -     | -       | -        | -  | -  | -     | -      | -     | -      |  |
| * 400x400  | -   | -     | -       | -        | -  | -  | -     | -      | -     | -      |  |
| * 500x400  | -   | -     | -       | -        | -  | -  | -     | -      | -     | -      |  |
| * 600x400  | -   | -     | -       | -        | -  | -  | -     | -      | -     | -      |  |
| • 800x400  | -   | -     | -       | -        | -  | -  | -     | -      | -     | -      |  |
| • 1000x400 | -   | -     | -       | -        | -  | -  | -     | -      | -     | -      |  |
| • 1200x400 | -   | -     | -       | -        | -  | -  | -     | -      | -     | -      |  |
| 200x500    | -   | -     | -       | -        | -  | -  | -     | -      | -     | -      |  |
| 300x500    | -   | -     | -       | -        | -  | -  | -     | -      | -     | -      |  |
| 400x500    | -   | -     | -       | -        | -  | -  | -     | -      | -     | -      |  |
| 500x500    | -   | -     | -       | -        | -  | -  | -     | -      | -     | -      |  |
| 600x500    | -   | -     | -       | -        | -  | -  | -     | -      | -     | -      |  |

• Rinforzo intermedio / Intermediate reinforcing

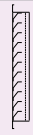
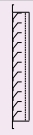
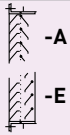

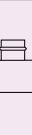
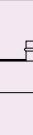
## PREZZI / PRICES

|  |  |  |  |  |  |  |  |  |  |  |  |
|--|---|---|---|---|---|---|---|---|---|---|--|
|  |   | GRA   | GRA-R   | GRA-R-Z   | GRA-R-SS  | SC  | CT  | PBZ 1   | PBZI 1  | PBZ 2   | PBZI 2   |
| BxH (mm)   | €   | €   | €   | €   | €   | €   | €   | €   | €   | €   | €  |
| • 800x500  | -   | -   | -   | -   | -   | -   | -   | -   | -   | -   | -  |
| • 1000x500   | -   | -   | -   | -   | -   | -   | -   | -   | -   | -   | -  |
| • 1200x500   | -   | -   | -   | -   | -   | -   | -   | -   | -   | -   | -  |
| 200x600  | -   | -   | -   | -   | -   | -   | -   | -   | -   | -   | -  |
| 300x600  | -   | -   | -   | -   | -   | -   | -   | -   | -   | -   | -  |
| 400x600  | -   | -   | -   | -   | -   | -   | -   | -   | -   | -   | -  |
| 500x600  | -   | -   | -   | -   | -   | -   | -   | -   | -   | -   | -  |
| 600x600  | -   | -   | -   | -   | -   | -   | -   | -   | -   | -   | -  |
| • 800x600  | -   | -   | -   | -   | -   | -   | -   | -   | -   | -   | -  |
| • 1000x600   | -   | -   | -   | -   | -   | -   | -   | -   | -   | -   | -  |
| • 1200x600   | -   | -   | -   | -   | -   | -   | -   | -   | -   | -   | -  |
| 200x800  | -   | -   | -   | -   | -   | -   | -   | -   | -   | -   | -  |
| 300x800  | -   | -   | -   | -   | -   | -   | -   | -   | -   | -   | -  |
| 400x800  | -   | -   | -   | -   | -   | -   | -   | -   | -   | -   | -  |
| 500x800  | -   | -   | -   | -   | -   | -   | -   | -   | -   | -   | -  |
| 600x800  | -   | -   | -   | -   | -   | -   | -   | -   | -   | -   | -  |
| • 800x800  | -   | -   | -   | -   | -   | -   | -   | -   | -   | -   | -  |
| • 1000x800   | -   | -   | -   | -   | -   | -   | -   | -   | -   | -   | -  |
| • 1200x800   | -   | -   | -   | -   | -   | -   | -   | -   | -   | -   | -  |
| 595x595<br>E.C. esterno<br>cornice overall<br>size | -   | -   | -   | -   | -   | -   | -   | -   | -   | -   | -  |

Per misure fuori tabella prezzi a richiesta

For bigger sizes prices on request

## • Rinforzo intermedio / Intermediate reinforcing

## VERNICIATURA:

Colori RAL 9010 - 9016 - 7035: + 15%

Altri colori: prezzi a richiesta

## DESCRIZIONI:

GRA: Griglia di ripresa passo 25 mm

GRA-R: Griglia di ripresa passo 25 mm con rete antivolatile

GRA-R-Z: Griglia di ripresa passo 25 mm con rete anti insetto (zanzariera)

GRA-R-SS-A: Griglia di ripresa passo 25 mm con rete antivolatile e serranda di sovrappressione a gravità (aspirazione)

GRA-R-SS-E: Griglia di ripresa passo 25 mm con rete antivolatile e serranda di sovrappressione a gravità (espulsione)

## ESECUZIONI SU RICHIESTA:

- Griglia completa di tegolo anti-pioggia +TEG

## ACCESSORI:

SC: Serranda di taratura ad alette con movimento contapposto

CT: Controtelaio di fissaggio in lamiera d'acciaio zincata

PBZ: Plenum di raccordo

## PAINING:

Color RAL 9010 - 9016 - 7035: + 15%

Different colors: prices on request

## DESCRIZIONI:

GRA: Return grille (25 mm between bars)

GRA-R: Return grille (25 mm between bars) with bird mesh

GRA-R-Z: Return grille (25 mm between bars) with insect screen.

GRA-R-SS-A: Return grille (25 mm between bars) with bird mesh and overpressure damper (aspiration)

GRA-R-SS-E: Return grille (25 mm between bars) with bird mesh and overpressure damper (expulsion)

## AVAILABLE ON REQUEST:

- Grille with rain-proof panel +TEG

## ACCESSORIES:

SC: Opposed blade damper

CT: Counterframes in galvanised steel sheet profile section

PBZ: Connecting plenum

DISEGNI / DRAWINGS

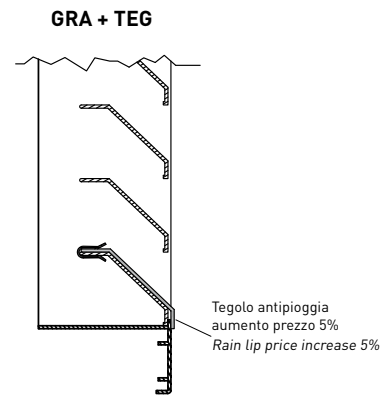
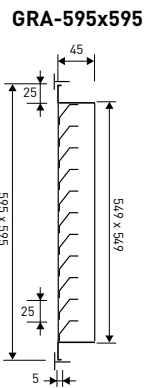
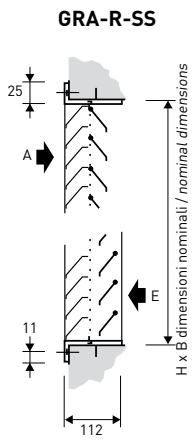
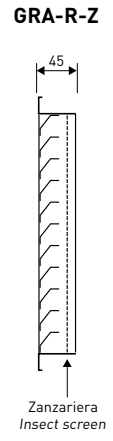
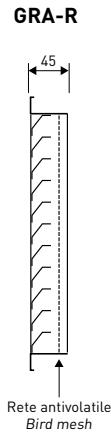
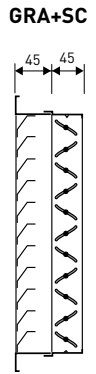
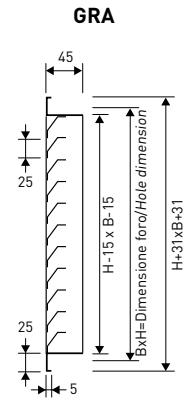

**TIPO DI FISSAGGIO / TYPE OF FIXING**

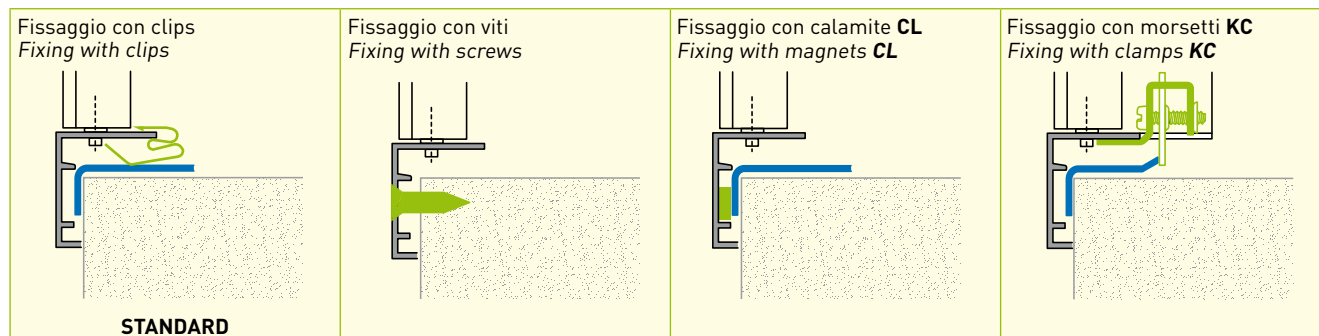

**FORI / HOLES**

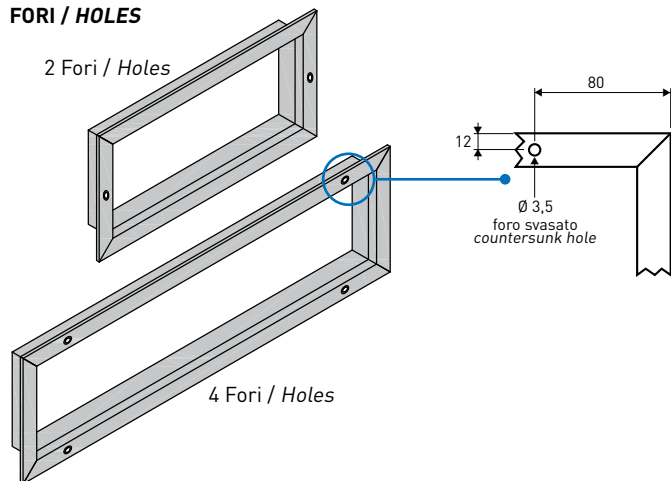

| Quantità di fori per le viti di fissaggio<br>Amount of holes for mounting screw |                             |     |     |     |      |
|---|-----------------------------|-----|-----|-----|------|
| Lato minore<br>Smaller side   | Lato maggiore / Longer side |     |     |     |      |
|   | 200                         | 250 | 300 | 350 | ≥400 |
| 100   | 2                           | 2   | 2   | 4   | 4    |
| 150   | 2                           | 2   | 2   | 4   | 4    |
| 200   | 2                           | 2   | 2   | 4   | 4    |
| ≥250  | 2                           | 2   | 2   | 4   | 4    |

**DISEGNI / DRAWINGS**

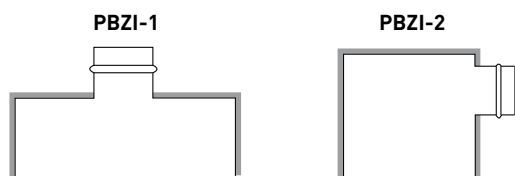
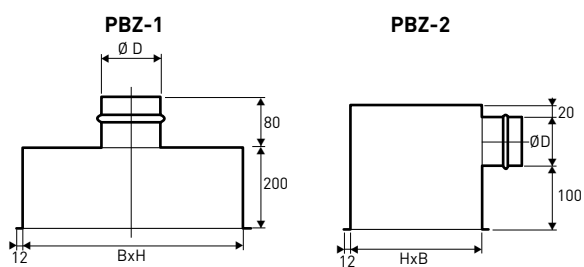

Plenum isolato esternamente spessore 6 mm  
Plenum externally insulated thickness 6 mm

DIAGRAMMA SCELTA RAPIDA / QUICK SELECTION DIAGRAM

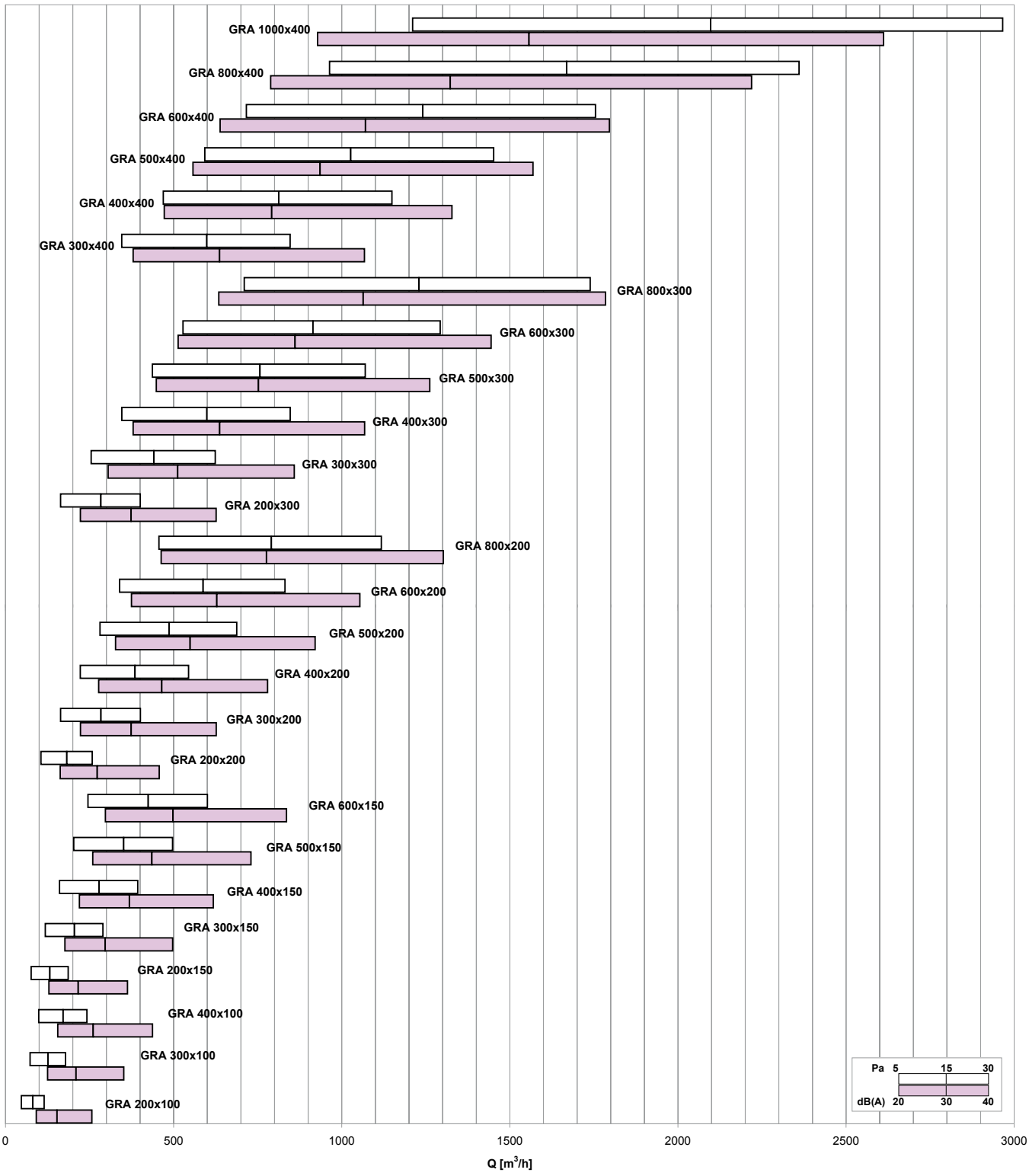

TABELLA DI SELEZIONE / SELECTION TABLE

| Modello<br>Model | A <sub>v</sub> [m <sup>2</sup> ] | Q [m <sup>3</sup> /h] |      | L <sub>WA</sub> [dB(A)] |     | Dp <sub>t</sub> [Pa] |     |
|------------------|----------------------------------|-----------------------|------|-------------------------|-----|----------------------|-----|
|                  |                                  | min                   | max  | min                     | max | min                  | max |
| GRA 200x100      | 0,0101                           | 50                    | 120  | -                       | 25  | 5                    | 30  |
| GRA 300x100      | 0,0157                           | 70                    | 180  | -                       | 27  | 5                    | 30  |
| GRA 400x100      | 0,0213                           | 100                   | 240  | -                       | 28  | 5                    | 30  |
| GRA 500x100      | 0,0269                           | 120                   | 310  | -                       | 30  | 5                    | 30  |
| GRA 600x100      | 0,0325                           | 150                   | 370  | -                       | 31  | 5                    | 30  |
| GRA 800x100      | 0,0437                           | 200                   | 500  | -                       | 33  | 5                    | 30  |
| GRA 1000x100     | 0,0548                           | 250                   | 620  | -                       | 34  | 5                    | 30  |
| GRA 1200x100     | 0,0660                           | 310                   | 750  | -                       | 35  | 5                    | 30  |
| GRA 200x150      | 0,0164                           | 80                    | 190  | -                       | 27  | 5                    | 30  |
| GRA 300x150      | 0,0255                           | 120                   | 290  | -                       | 30  | 5                    | 30  |
| GRA 400x150      | 0,0346                           | 160                   | 390  | -                       | 31  | 5                    | 30  |
| GRA 500x150      | 0,0437                           | 200                   | 500  | -                       | 33  | 5                    | 30  |
| GRA 600x150      | 0,0528                           | 250                   | 600  | -                       | 34  | 5                    | 30  |
| GRA 800x150      | 0,0709                           | 330                   | 810  | -                       | 35  | 5                    | 30  |
| GRA 1000x150     | 0,0891                           | 410                   | 1010 | -                       | 36  | 5                    | 30  |
| GRA 1200x150     | 0,1073                           | 500                   | 1220 | 20                      | 38  | 5                    | 30  |
| GRA 200x200      | 0,0227                           | 110                   | 260  | -                       | 29  | 5                    | 30  |
| GRA 300x200      | 0,0353                           | 160                   | 400  | -                       | 31  | 5                    | 30  |
| GRA 400x200      | 0,0478                           | 220                   | 540  | -                       | 33  | 5                    | 30  |
| GRA 500x200      | 0,0604                           | 280                   | 690  | -                       | 34  | 5                    | 30  |
| GRA 600x200      | 0,0730                           | 340                   | 830  | -                       | 35  | 5                    | 30  |
| GRA 800x200      | 0,0982                           | 460                   | 1120 | -                       | 37  | 5                    | 30  |
| GRA 1000x200     | 0,1234                           | 570                   | 1400 | 21                      | 38  | 5                    | 30  |
| GRA 1200x200     | 0,1486                           | 690                   | 1690 | 22                      | 39  | 5                    | 30  |
| GRA 200x300      | 0,0352                           | 160                   | 400  | -                       | 31  | 5                    | 30  |
| GRA 300x300      | 0,0548                           | 250                   | 620  | -                       | 34  | 5                    | 30  |
| GRA 400x300      | 0,0744                           | 350                   | 850  | -                       | 36  | 5                    | 30  |
| GRA 500x300      | 0,0940                           | 440                   | 1070 | -                       | 37  | 5                    | 30  |
| GRA 600x300      | 0,1136                           | 530                   | 1290 | 21                      | 38  | 5                    | 30  |
| GRA 800x300      | 0,1528                           | 710                   | 1740 | 22                      | 40  | 5                    | 30  |
| GRA 1000x300     | 0,1920                           | 890                   | 2190 | 23                      | 41  | 5                    | 30  |
| GRA 1200x300     | 0,2312                           | 1070                  | 2630 | 24                      | 42  | 5                    | 30  |
| GRA 200x400      | 0,0478                           | 220                   | 540  | -                       | 33  | 5                    | 30  |
| GRA 300x400      | 0,0744                           | 350                   | 850  | -                       | 36  | 5                    | 30  |
| GRA 400x400      | 0,1010                           | 470                   | 1150 | -                       | 37  | 5                    | 30  |
| GRA 500x400      | 0,1276                           | 590                   | 1450 | 21                      | 38  | 5                    | 30  |
| GRA 600x400      | 0,1542                           | 720                   | 1750 | 22                      | 39  | 5                    | 30  |
| GRA 800x400      | 0,2073                           | 960                   | 2360 | 24                      | 41  | 5                    | 30  |
| GRA 1000x400     | 0,2605                           | 1210                  | 2970 | 25                      | 42  | 5                    | 30  |
| GRA 1200x400     | 0,3137                           | 1460                  | 3570 | 26                      | 43  | 5                    | 30  |
| GRA 200x500      | 0,0603                           | 280                   | 690  | -                       | 34  | 5                    | 30  |
| GRA 300x500      | 0,0939                           | 440                   | 1070 | -                       | 37  | 5                    | 30  |
| GRA 400x500      | 0,1275                           | 590                   | 1450 | 21                      | 38  | 5                    | 30  |
| GRA 500x500      | 0,1611                           | 750                   | 1830 | 23                      | 40  | 5                    | 30  |
| GRA 600x500      | 0,1947                           | 900                   | 2220 | 23                      | 41  | 5                    | 30  |
| GRA 800x500      | 0,2619                           | 1220                  | 2980 | 25                      | 42  | 5                    | 30  |
| GRA 1000x500     | 0,3291                           | 1530                  | 3750 | 26                      | 44  | 5                    | 30  |
| GRA 1200x500     | 0,3963                           | 1840                  | 4510 | 27                      | 45  | 5                    | 30  |
| GRA 200x600      | 0,0729                           | 340                   | 830  | -                       | 35  | 5                    | 30  |
| GRA 300x600      | 0,1135                           | 530                   | 1290 | 21                      | 38  | 5                    | 30  |
| GRA 400x600      | 0,1541                           | 720                   | 1750 | 22                      | 40  | 5                    | 30  |
| GRA 500x600      | 0,1947                           | 900                   | 2220 | 23                      | 41  | 5                    | 30  |
| GRA 600x600      | 0,2353                           | 1090                  | 2680 | 25                      | 42  | 5                    | 30  |
| GRA 800x600      | 0,3165                           | 1470                  | 3600 | 26                      | 44  | 5                    | 30  |
| GRA 1000x600     | 0,3977                           | 1850                  | 4530 | 28                      | 45  | 5                    | 30  |
| GRA 1200x600     | 0,4789                           | 2230                  | 5450 | 29                      | 46  | 5                    | 30  |
| GRA 200x800      | 0,0980                           | 460                   | 1120 | -                       | 37  | 5                    | 30  |
| GRA 300x800      | 0,1526                           | 710                   | 1740 | 22                      | 40  | 5                    | 30  |
| GRA 400x800      | 0,2072                           | 960                   | 2360 | 24                      | 41  | 5                    | 30  |
| GRA 500x800      | 0,2618                           | 1220                  | 2980 | 25                      | 42  | 5                    | 30  |
| GRA 600x800      | 0,3164                           | 1470                  | 3600 | 26                      | 44  | 5                    | 30  |
| GRA 800x800      | 0,4256                           | 1980                  | 4850 | 28                      | 45  | 5                    | 30  |
| GRA 1000x800     | 0,5348                           | 2490                  | 6090 | 29                      | 46  | 5                    | 30  |
| GRA 1200x800     | 0,6440                           | 2990                  | 7330 | 30                      | 47  | 5                    | 30  |
| GRA 595x595      | 0,1957                           | 910                   | 2230 | 24                      | 41  | 5                    | 30  |